

Space Flight Heritage of Optical Fiber Cables

Douglas Hardy

W. L. Gore & Associates

Newark, Delaware, U.S.A.

Space Flight Heritage of Optical Fiber Cables

W. L. Gore & Associates

- Founded in 1958
- First products were high performance PTFE-insulated cables
- 1969 – Gore cable deployed on surface of the moon during Apollo 11 mission
- Today, a leading manufacturer of cable and cable assemblies for the space community consisting of the following product categories:
 - ESA-qualified electrical cable and cable assemblies
 - Microwave cable assemblies
 - Fiber optic cable & cable assemblies

Space Flight Heritage of Optical Fiber Cables

10+ years of Optical Cables in Space

- Space Shuttle
- Mercury Laser Altimeter (MLA)
- Geoscience Laser Altimeter System (GLAS)
- Classified Satellite Programs (multiple)

- Replacing heavier electrical wiring -or-
- Allows new design + performance possibilities

Space Flight Heritage of Optical Fiber Cables

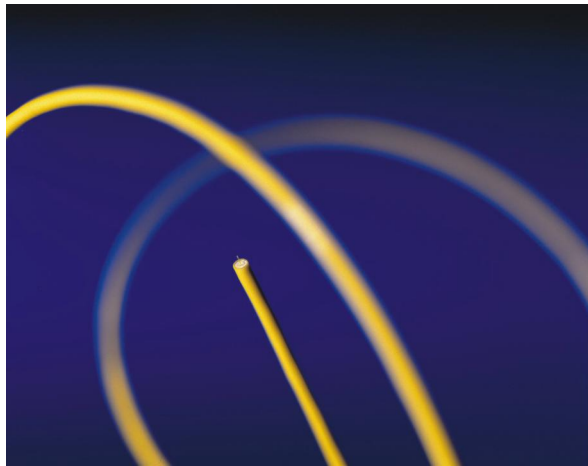

Simplex fiber optic cables assemblies are being used today in satellites

Challenges to Fiber Optic Implementation

- Temperature extremes
- Outgassing
- Radiation
- Mechanical shock & vibration

Space Flight Heritage of Optical Fiber Cables

Glass Coating Options

	Units	Acrylate Coating	High Temperature Acrylate Coating	Silicone	Polyimide Coating
Upper Service Temp.	°C	85	125	200	300+

Buffer & Jacket Ratings

	Units	Hytrel®	Tefzel®	FEP	PFA	PTFE
Upper Service Temp.	°C	135 – 180	180	204	260	260

Space Flight Heritage of Optical Fiber Cables

Microbending in Optical Fibers

- Microbending loss in optical fibers is the loss of optical power from guided modes to lossy modes which dissipate the energy from the core of the fiber.
- Prior to development of optical fibers, microbend loss was already established in the optical waveguide community.
- In the early 1970's, microbending loss in optical fibers was being explored and reported in the literature.
- Hanson et al. (1980) concisely combined modal coupling theory and thermo-mechanical analysis into a general loss model for temperature-dependent microbend loss.

Space Flight Heritage of Optical Fiber Cables

Microbending Loss

- Microbends are typically nanometer displacements of the fiber axis correlated over millimeter lengths.
- Loss is due to the coupling of light from high order modes to “lossy” modes.

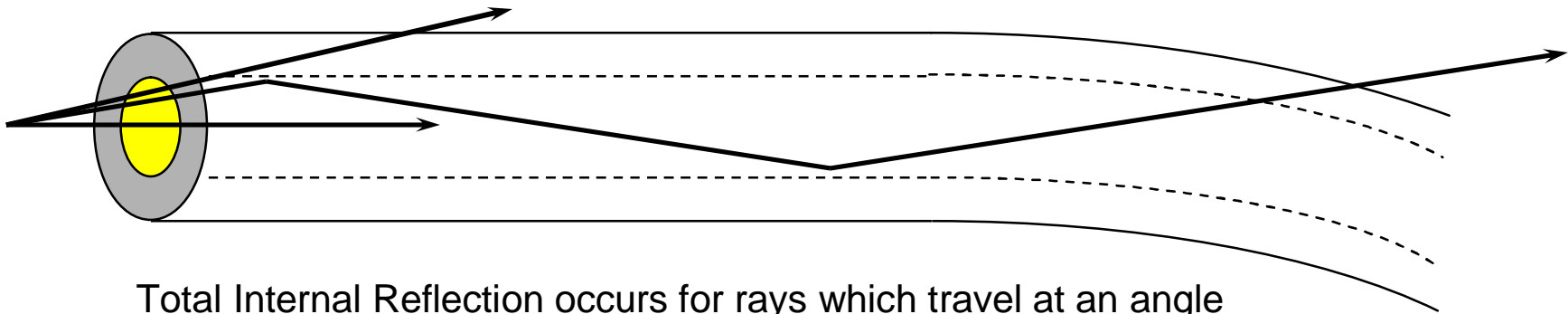

Total Internal Reflection occurs for rays which travel at an angle (relative to the core/cladding interface) which is less than the critical angle, θ_{critical} .

Space Flight Heritage of Optical Fiber Cables

Microbending

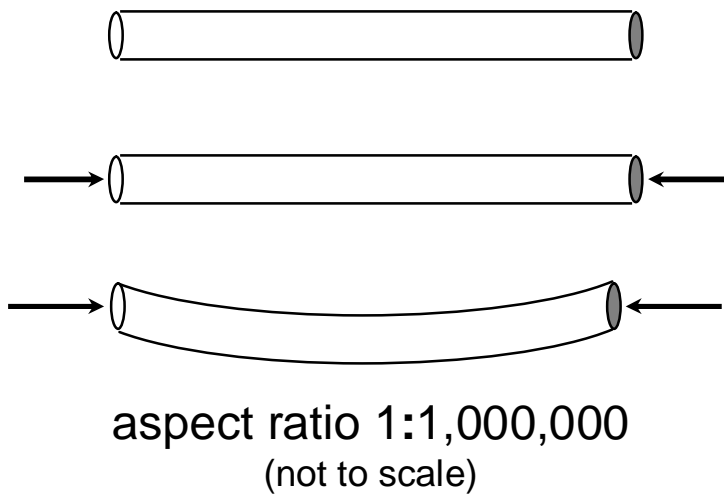

Coating and Buffer Eccentricity plays an important role:

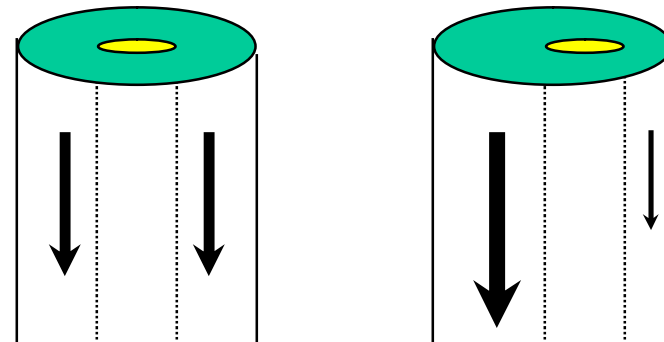

Hanson Model of Thermally-Induced Loss

Induced loss (in dB/km) below the equilibrium temperature, T_0 , is given by

$$\gamma = 4.506 \times 10^7 (\alpha_3 \Delta T)^2 \frac{e^2 (\delta\beta_0)}{\delta k} \left(\frac{E_3 E_2}{(b_2 - b_1) E_1^2} \right)^2 \left(\frac{a}{b_1} \right)^8 \frac{c}{b_1^2 \Delta^5}$$

where:

α_3 = CTE of buffer

ΔT = temperature difference

$e(\delta\beta_0)$ = eccentricity

E1, E2, E3 = fiber, coating, and buffer moduli

b_1, b_2 = radius of fiber, coating

a = core radius

Δ = normalized refractive index difference

c = index gradient factor

δk = width of Fourier transform of the power spectrum of the fiber curvature

- The model does not account for the effect of shrinkage
- It was not developed for single-mode constructions, and therefore must be modified to do so.

If we wish to use Hanson's model without further modification, then we would expect that if we plot induced attenuation vs. temperature, then we should be able to fit the data below T_0 with the equation:

$$Y = A + B(T_0 - T)^2$$

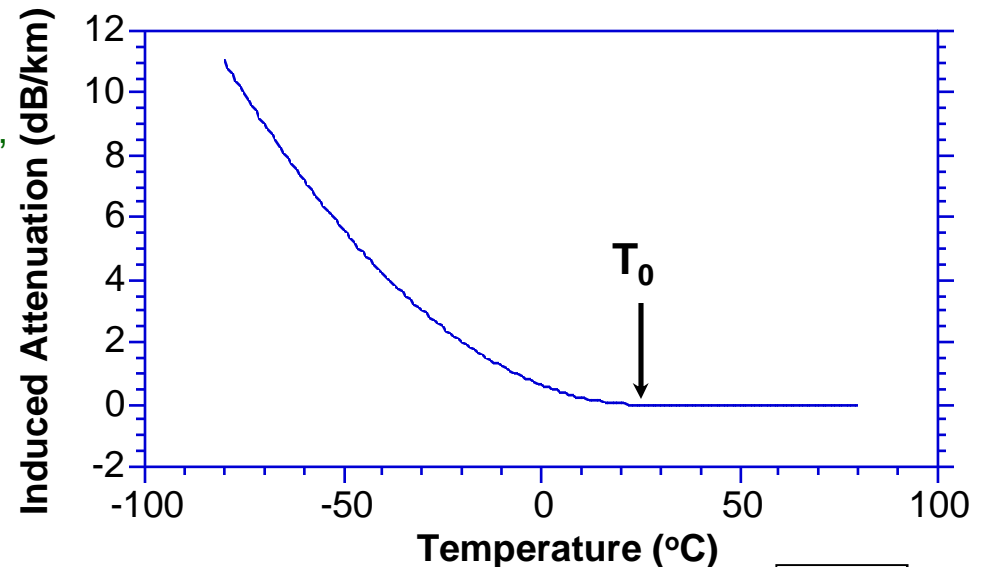

Space Flight Heritage of Optical Fiber Cables

Mechanisms of Thermally-Induced Microbend Loss

- Thermal Expansion/Contraction
 - Polymer CTE's are typically 10-1000x that of glass.
 - CTE difference leads to compression of optical fiber at low temperatures.

<u>Sample</u>	<u>Effective Compressive Force (lbs)</u>
Polyimide-coated fiber/PEEK	2.01
Polyimide-coated fiber/ePTFE/FEP	1.31
Acrylate-coated fiber/FEP	1.08
Acrylate-coated fiber/ePTFE/Polyurethane	0.05

- Shrinkage
 - At higher temperatures, polymer chain mobility increases. This allows relaxation of internal stress and frozen strains.
 - If a polymeric buffer is maintained at a temperature near or above its glass transition temperature, stress relaxation will occur. For axially stressed layers (such as extruded buffers), axially shrinkage will occur. This will tend to increase the compressive force that the fiber experiences.

Space Flight Heritage of Optical Fiber Cables

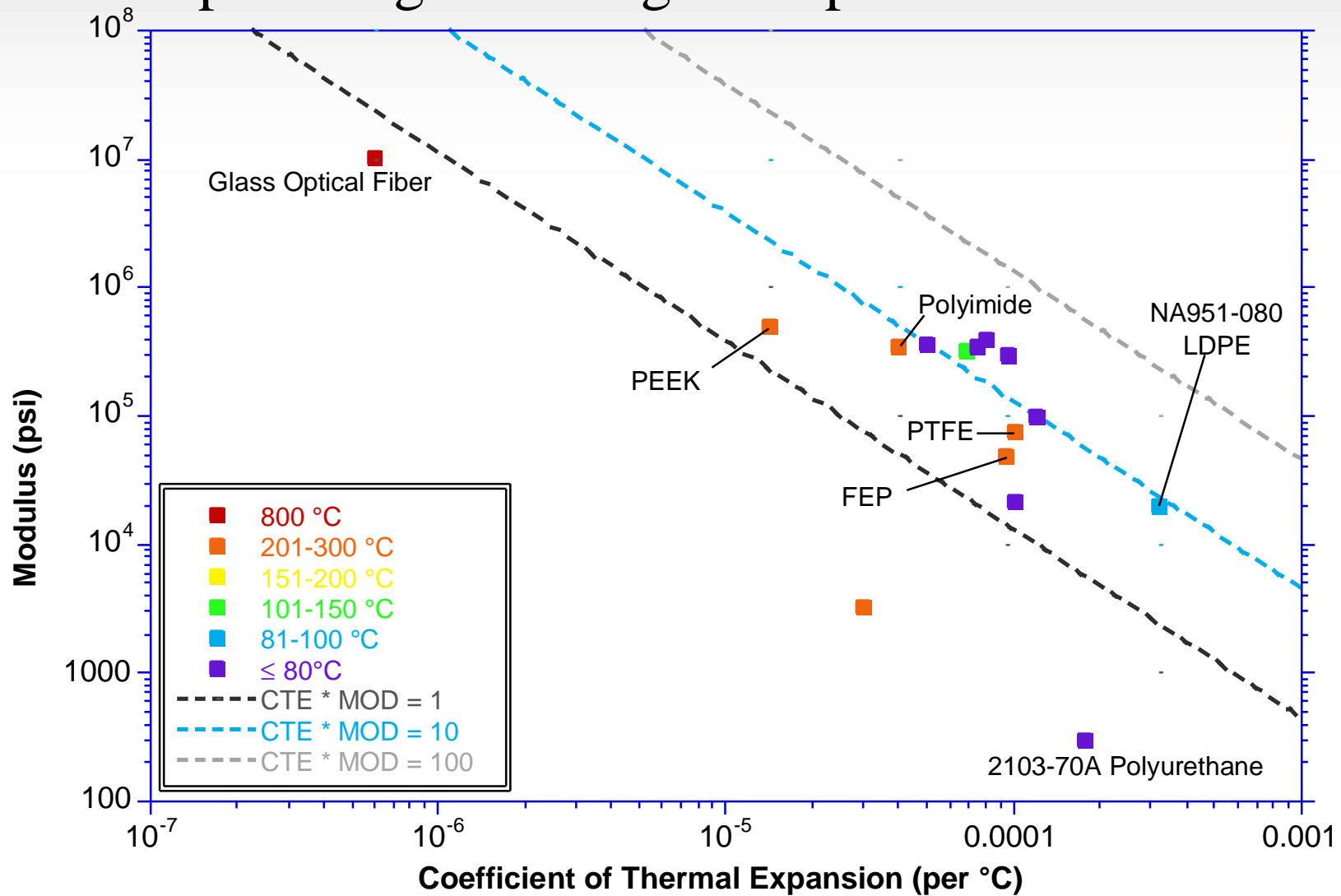

Space Flight Heritage of Optical Fiber Cables

Mechanisms of Thermally-Induced Microbend Loss

- All Gore designs incorporate a layer of ePTFE directly over the coated fiber.
- ePTFE buffer is an open cell structure, 75% air and 25% PTFE.
- This layer does not influence the effect of the primary coating (acrylate, polyimide, etc.) on the fiber – typically 60 μm thick.
- This layer does significantly mitigate the CTE effects of all other layers *e.g.* braids and cable jackets – typically 100 – 250 μm thick.
- Microbend sensitivity of any particular cable depends on factors such as:
 - Single-mode vs. multimode
 - Core size
 - Numerical aperture
 - Operational temperature range
 - Wavelength

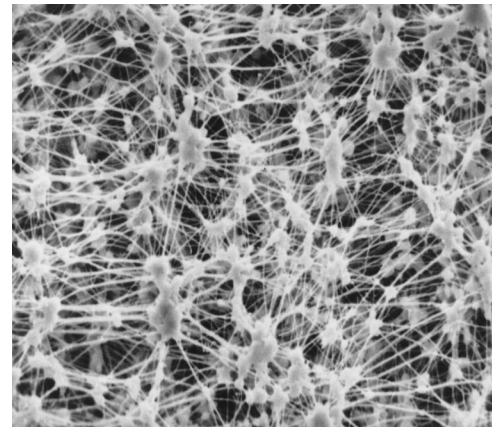

ePTFE Micrograph

Space Flight Heritage of Optical Fiber Cables

Mechanisms of Thermally-Induced Microbend Loss

Tight Tube Buffer

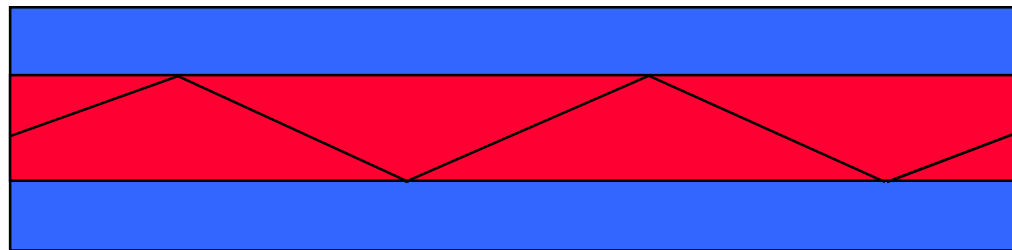
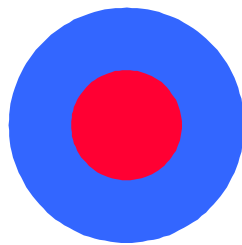

25 C

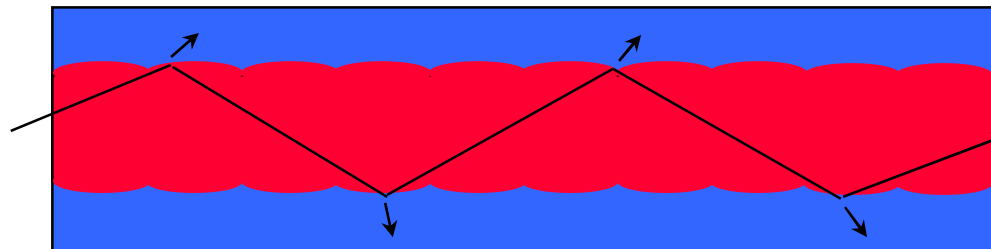
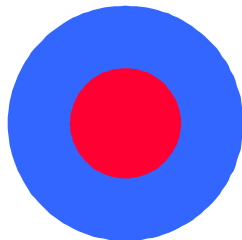

-55 C

Short term - higher optical attenuation

Long term - may promote crack growth in fiber

Space Flight Heritage of Optical Fiber Cables

Mechanisms of Thermally-Induced Microbend Loss

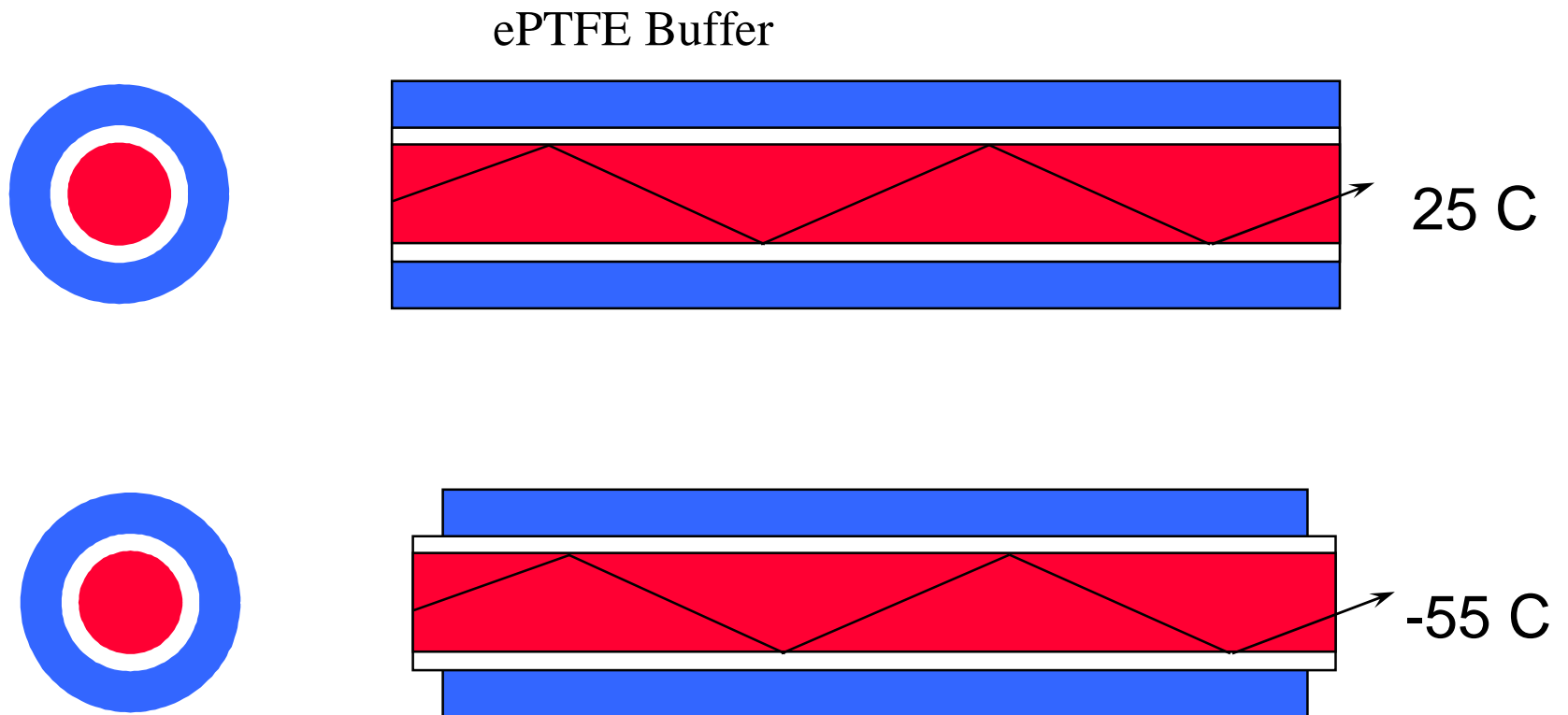

Space Flight Heritage of Optical Fiber Cables

OPTICAL POWER OUTPUT AFTER THERMAL CYCLING
 2 VARIETIES of 62.5 μm optical cable

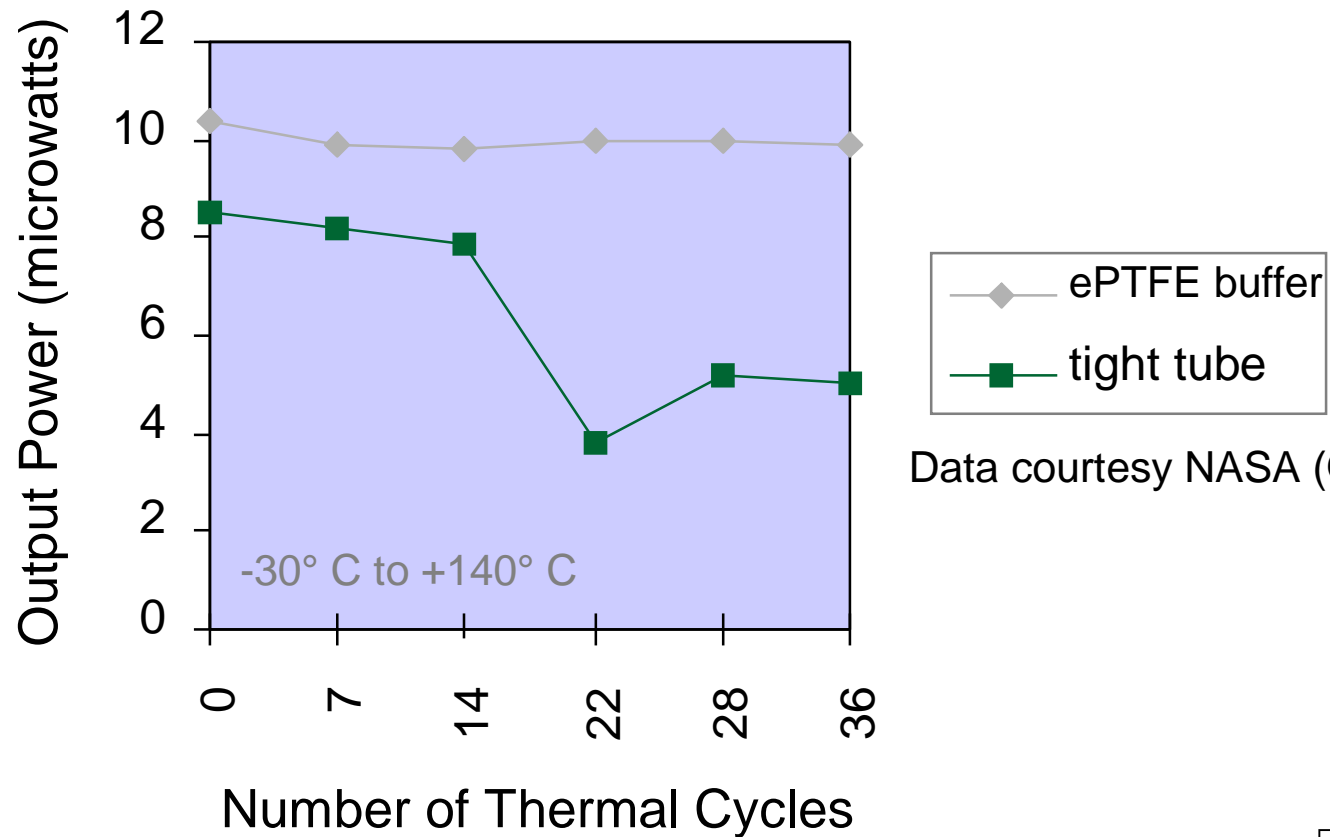

Data courtesy NASA (Ott, 1998)

Space Flight Heritage of Optical Fiber Cables

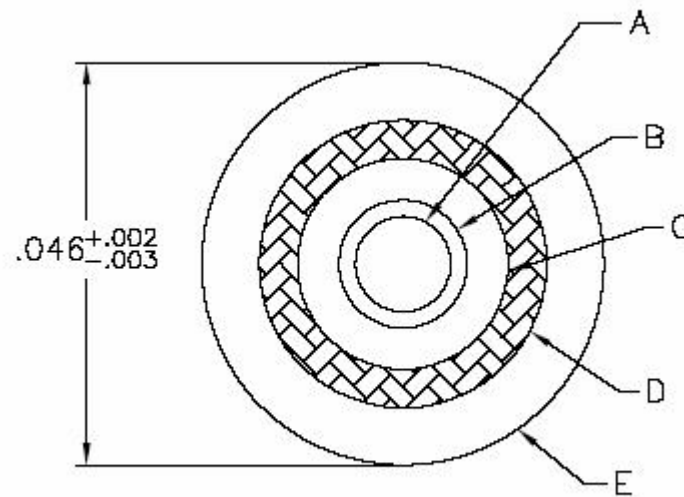

- A - Optical Fiber**
- B - Expanded PTFE buffer**
- C - Fluoropolymer jacket**
- D - Aramid braid**
- E - Fluoropolymer jacket**

1.2 mm Cable

Only single-mode fiber optic cable qualified for space flight use

IAW SAE Aerospace Standard AS5382/3

Space Flight Heritage of Optical Fiber Cables

Outgassing

All materials meet ASTM E595 requirements:

TML < 1.0%

CVCM < 0.1%

Mechanical Shock & Vibration

Cable tested in qualification to:

15 - 40 g's vibration $\Delta < .05$ dB/50 m

launch shock $\Delta < .05$ dB/50 m

Space Flight Heritage of Optical Fiber Cables

Radiation

Fiber selection is critical

Many studies in the literature

Main factors are:

- glass dopants
- operational wavelength

All other cable materials will survive > 10 MRad γ radiation

Space Flight Heritage of Optical Fiber Cables

Ribbon Cable

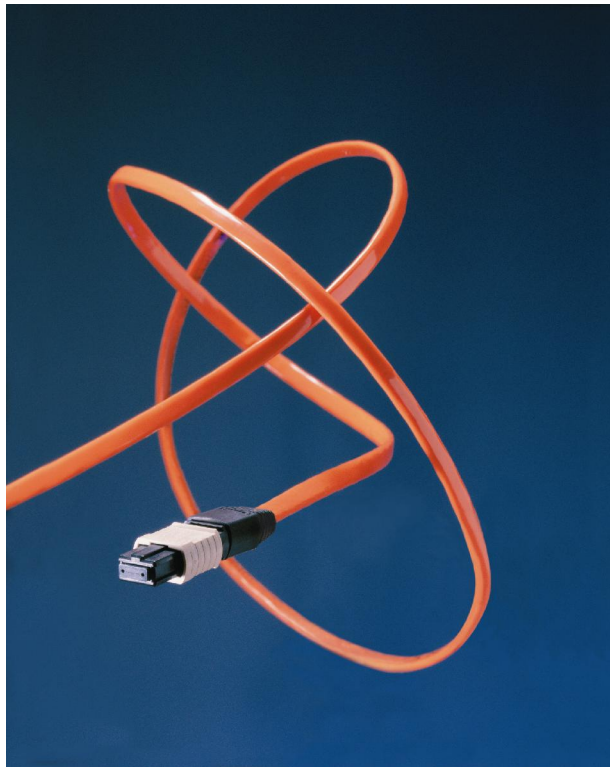

Array of 12 fibers

Has been characterized for
space flight usage

Meets same requirements as
simplex cable

Scheduled for deployment
in space in 2006

Space Flight Heritage of Optical Fiber Cables

Conclusion

- Space environments require specialized fiber optic cables for reliable performance.
- Due to the wide operational temperature ranges in space, thermally-induced microbending is a real phenomenon to be managed.
- An expanded PTFE buffering system can minimize microbend-induced attenuation changes.
- Other environmental issues such as outgassing and radiation may be managed with careful selection of optical fiber type and other materials.
- Fiber optic cable & cable assemblies have been deployed in space and are performing reliably.